

POP Nut™ PNT410

POP®

Heavy Duty Lever Tool

- ES** Remachadora Profesional Tipo Palanca
- PT** Rebitadeira para uso pesado tipo Alavanca
- FR** Pince à leviers pour inserts de grands diamètres
- DE** Hochleistungs-Hebelwerkzeug
- SE** Robust tvåhandsverktyg för medelstor produktion
- DK** Tohåndstang med stor nittekræft – til små og mellemstore produktioner
- FI** Sisäkierreniitti – vipuvarsipihdit – M 12 saakka
- JP** 強力型レバー式ポップナットツール

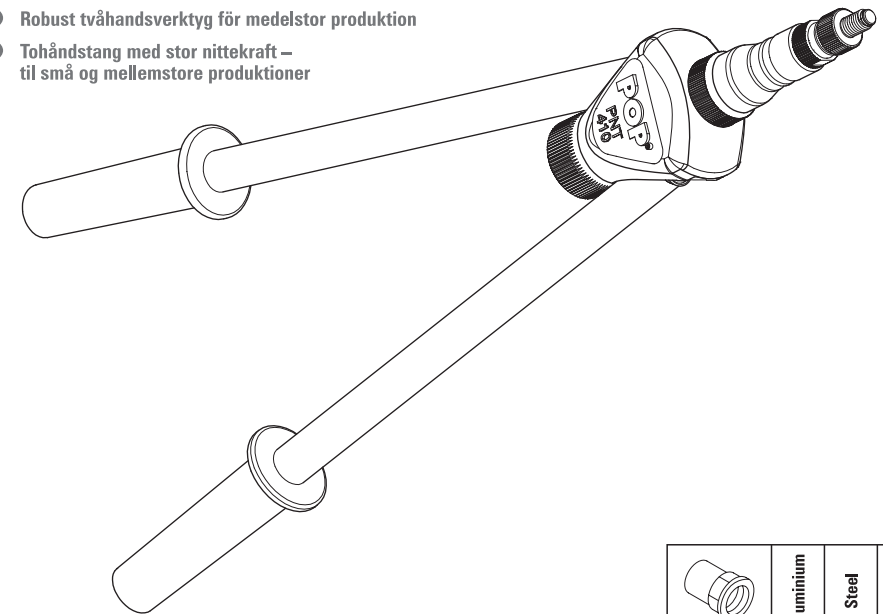



- GB** Read the Manual
- ES** Leer el Manual
- PT** Leia o manual
- FR** Lire le manuel
- DE** Lesen Sie die Betriebsanleitung
- SE** Läs manualen
- DK** Læs manualen grundigt
- FI** Kts. huolto-ohjeet
- JP** 取扱説明書をお読みください。



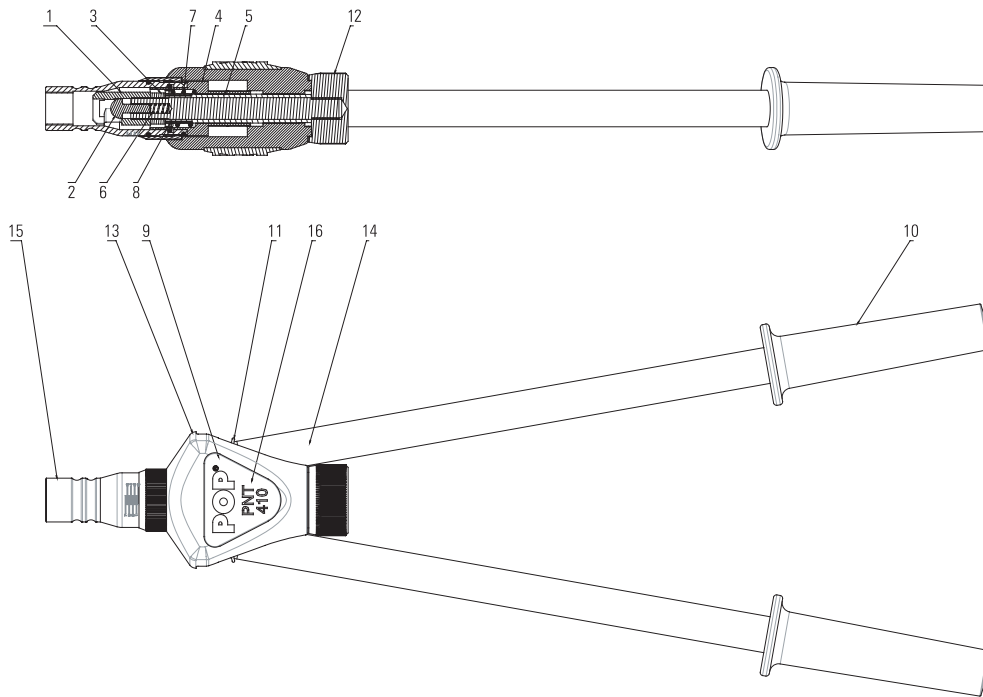

- Wear Safety Goggles
- Usar Gafas de Seguridad
- Use Óculos de Proteção
- Porter des lunettes de protection
- Tragen Sie eine Schutzbrille
- Använd säkerhetsglasögon (eller glasögon)
- Anvend beskyttelsesbriller
- Käytä suojasilmälaseja
- 保護めがねを着用してください。



1	DPM400-345	1
2	DPM400-346	1
3	DPM400-356	1
4	DPM400-493	1
5	DPM400-351	1
6	DPM400-360	1
7	DPM400-359	1
8	DPM400-355	1
9	DPM400-117	2
10	DPM400-120	2
11	DPM400-357	2
12	FAM400-354	1
13	DPM400-495	1
14	FAM400-342	2
15	DPM400-494	1
16	DPM400-358	2

PNT 410 M	  		
	M5	DPM400-336	FAM400-171
	M6	DPM400-337	FAM400-173
	M8	DPM400-338	FAM400-176
	M10	DPM400-339	FAM400-178
M12	DPM400-340	FAM400-208	

TK, TL & TH SERIES ONLY

PNT 410 IP	  		
	10-24unc	DPM400-475	FAM400-430
	10-32unf	DPM400-476	FAM400-430
	1/4-20unc	DPM400-477	FAM400-431
	5/16-18unc	DPM400-478	FAM400-432
	3/8-16unc	DPM400-479	FAM400-433
1/2-13unc	DPM400-480	FAM400-434	

Additional nosepieces are available – refer to www.emhart.com

PNT 410 M				
	M5	Aluminium	Steel	Stainless Steel
	M6	✓	✓	✓
	M8	✓	✓	✓
	M10	✓	✓	✓
M12	✓	✓	✓	

PNT 410 IP				
	10-24unc	✓	✓	✓
	10-32unf	✓	✓	✓
	1/4-20unc	✓	✓	✓
	5/16-18unc	✓	✓	✓
	3/8-16unc	✓	✓	✓
1/2-13unc	✓	✓	✓	

